

新竹縣原住民族地區建築標準圖說

1-SC-1-1-0

結構計算書

Job No. 2208A

2021/1

簽證建築師：陳俊宏建築師事務所

陳俊宏



樂力結構技師事務所

LÓO-LÀ Tstructure engineering studio

T e l : 0 6 - 2 0 3 3 1 7 3

M o b i l e : 0 9 2 1 - 2 7 9 2 1 4

M a i l : r 9 4 5 2 1 2 2 5 @ n t u . e d u . t w

7 1 0 - 0 4 6 台南市永康區永平街771號



目錄

- 1.0 建築概要 / Introduction**
- 2.0 結構系統說明 / Structural System Description**
- 3.0 結構材料 / Structural Materials**
- 4.0 設計載重 / Design Loadings**
 - 4.1 靜載重及活載重 / Dead Loads & Live Loads
 - 4.2 設計地震力及分析結果 / Seismic Loads & Analysis result
 - 4.3 設計風力 / Wind Loads
 - 4.4 載重組合 / Loading Combination
- 5.0 工作載重結構行為限制 / Serviceability Performance**
- 6.0 設計規範 / Design Code**
- 7.0 結構分析程序 / Summary of Structural Analysis Procedures**
 - 7.1 結構模型 / Structural Modeling
 - 7.2 RC 樑結構設計
 - 7.3 RC 柱結構設計
- 9.0 基礎設計 / Foundation Design**
 - 9.1 基礎設計說明
 - 9.2 基礎分析
 - 9.3 基礎結構設計
- 10.0 其他結構檢核 / Structure Detail Checking**
 - 10.1 RC 樓板設計

- 附錄 參考結構圖說
 - ETABS 輸入檔
 - ETABS 輸出檔
 - SAFE 輸入檔
 - SAFE 輸出檔



建築結構設計基本資料表

一、構造種類

- 鋼筋混凝土構造
- 鋼骨構造
- 鋼骨鋼筋混凝土構造
- 其他

二、結構系統之規劃及分析

- 韌性抗彎矩構架系統
- 二元系統
- 其他
具對角斜撐之輕型構架

三、結構材料

1. 混凝土
 $f_c' = 280 \text{ kgf/cm}^2$
2. 鋼筋
#4(D13)以上： $f_y = 4200 \text{ kgf/cm}^2$
(CNS 560 A2006 SD420W)
#3(D10)以下： $f_y = 2800 \text{ kgf/cm}^2$
(CNS 560 A2006 SD280W)
3. 鋼結構
SGC440 3400 kgf/cm^2

活載重 LL		kgf/m ²
1F	住宅	200
PRF	屋頂	60

四、水平側向力、風力檢核分析

(一) 地震力

1. 新竹縣五峰鄉
2. $S_S^D = 0.7$, $S_1^D = 0.4$
 $S_S^M = 0.9$, $S_1^M = 0.5$
3. $I = 1.10$
4. $R_x = 3$, $R_y = 3$
5. $\alpha_y = 1.0$
6. 建築物基本震動週期 $T_x = 0.05 h_n^{3/4}$
 $T_y = 0.05 h_n^{3/4}$
7. $V_x / W = 0.264$
 $V_y / W = 0.263$

(二) 風力

基本設計風速每秒 32.5 公尺區
 $I = 1.1$, 地況: B

五、層間最大變位與層間變位角

(X-Dir.)

1. 最大層間變位角 = 0.005‰
2. 最大位移 = 0.002cm

(Y-Dir.)

1. 最大層間變位角 = 0.004‰
2. 最大位移 = 0.002cm

七、結構設計

- ASD
- USD
- LRFD

八、基礎設計

- 獨立基腳或聯合基腳
- 筏式基礎
- 樁基礎
- 其他
版式基礎



九、基礎開挖擋土支保措施

- 斜坡明挖
- 預壘排樁
- 地下連續壁
- 其他



1.0 建築概要

本案為標準圖說，工程可能位於新竹縣五峰鄉/尖石鄉/關西鎮，為地上 1 樓之輕型鋼構造，樓高約 2.7 公尺。

建築基地：新竹縣五峰鄉/尖石鄉/關西鎮

建築規模：地上 1 層

開挖深度：0.4m



2.0 結構系統說明

地震力分析：法規靜力分析

基本資料：

建築種類：鋼筋混凝土構造(RC)\鋼骨構造(SS)

結構系統：其他\具對角斜撐之輕型構架

樓層概述：

樓層	高度(cm)	用途
1F	222.5	住宅
1F 抬高	47.5	

樓版厚度：

基礎版 40cm RC 版

PRF 彩浪鋼版

開挖方式：

斜坡明挖

分析程式： ETABS V9.5



3.0 結構材料

3.1 混凝土

材料特性:

波松比	0.2
彈性模數(楊式係數)	$15000 \sqrt{fc'}$ kgf/cm ²
線性熱膨脹係數	1.2×10^{-5} 1/ °C
混凝土規定抗壓強度 fc'	同建築結構設計基本資料表
單位重	2400 kgf/m ³

3.2 鋼筋

彈性模數(楊式係數)	2.04×10^6 kgf/cm ²
鋼筋規定降伏強度 fy	同建築結構設計基本資料表
點焊鋼線網	ASTM A706, $F_y=5000$ kgf/cm ²

3.3 結構鋼

材料特性:

波松比	0.3
彈性模數(楊式係數)	2.04×10^6 kgf/cm ²
線性熱膨脹係數	1.2×10^{-5} 1/ °C
標稱降伏應力 fy	同建築結構設計基本資料表
單位重	7850 kgf/m ³

螺栓及焊材

高拉力螺栓	F10T
錨定螺栓	ASTM A307, ASTM A325
焊材	E80xx



4.0 設計載重

4.1 靜載重及活載重

靜載重

PRF

載重種類	數量	單位重	總重
設備管線	1 式	40 kgf/m ²	40 kgf/m ²

外加靜載重(SDL) 40 kgf/m²

2F~R1F 室內

載重種類	數量	單位重	總重
鋪面裝修	1 式	40 kgf/m ²	40 kgf/m ²

外加靜載重(SDL) 40 kgf/m²

活載重 (kgf/m²)

同建築結構設計基本資料表

樓層載重資料

樓層	面積(m ²)	重量(tf)	單位重(tf/m ²)
PRF	8.41	0.13	0.015
1F	8.41	0.51	0.060



4.2 設計地震力及分析結果

依據「建築物耐震設計規範及解說，內政部」，設計地震力為：

$$V = \frac{I}{1.4\alpha_y} \left(\frac{S_{aD}}{F_u} \right)_m W$$

式中

$$\left(\frac{S_{aD}}{F_u} \right)_m = \begin{cases} \frac{S_{aD}}{F_u} & \frac{S_{aD}}{F_u} \leq 0.3 \\ 0.52 \frac{S_{aD}}{F_u} + 0.144 & 0.3 < \frac{S_{aD}}{F_u} < 0.8 \\ 0.70 \frac{S_{aD}}{F_u} & \frac{S_{aD}}{F_u} \geq 0.8 \end{cases}$$

S_{aD} 工址設計水平譜加速度係數，為工址水平加速度與重力加速度 g 之比值。

W 建築物全部靜載重。活動隔間應計入 75kg/m^2 之重量；一般倉庫、書庫應計入至少四分之一活載重；水箱、水池等容器，應計入全部內容物之重量。

I 用途係數。

α_y 起始降伏地震力放大倍數，依耐震設計規範第一章第 9 節規定，鋼結構採容許應力法設計可取 1.2，採極限設計法取 1.0。就鋼筋混凝土結構而言，以極限強度設計法可採 1.0。

F_u 結構系統地震力折減係數，依耐震設計規範第二章第 9 節規定。

※本案為一般建築物，由於本案為泛用之標準圖說，設立之位置較廣，考量其變異性用途係數保守採用 1.1。



地震力計算詳下表

基地基本資料					斷層資料	
縣市	鄉鎮市區	里	震區種類	地盤種類	附近斷層	距離斷層
新竹縣	五峰鄉	所有里	一般震區	第一類地盤(自行決定地盤種類)	獅潭與神卓山(一般情況)	10(km)

譜加速度係數		近斷層因子		工址放大因子		修正譜加速度係數		分界週期	
S_S^D	0.7	設計	N_a	1	F_a	1	$S_{DS}=F_a \times N_a \times S_S^D$	0.7	$T_0^D=S_{D1}/S_{DS}$
S_1^D	0.4		N_v	1	F_v	1	$S_{D1}=F_v \times N_v \times S_1^D$	0.4	0.571
S_S^M	0.9	最大	N_a	1	F_a	1	$S_{MS}=F_a \times N_a \times S_S^M$	0.9	$T_0^M=S_{M1}/S_{MS}$
S_1^M	0.5		N_v	1	F_v	1	$S_{M1}=F_v \times N_v \times S_1^M$	0.5	0.556

建築基本資料							
屋頂層數	樓層數	地下層數	1F抬高	屋頂高度	建築高度	地下高度	h_n (基面至屋頂)
0 F	1 F	0 F	0(m)	0(m)	2.7(m)	0(m)	2.7(m)

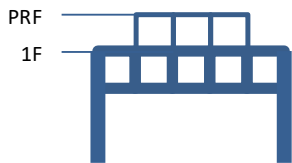

	建築結構系統	
	X方向	Y方向
結構阻尼比	0.02	
結構系統	其他構造	其他構造
T_{code} (法規週期)	$0.05 \times h_n^{3/4} = 0.105(s)$	$0.05 \times h_n^{3/4} = 0.105(s)$
T_{max} (上限週期)	$1.4 \times T_{code} = 0.147(s)$	$1.4 \times T_{code} = 0.147(s)$
I(用途係數)	1.1	
設計規範	鋼構(LRFD)	
α_y	1	

各方向地震力計算		X方向	Y方向
1. 建築結構系統 相關資料	T_{dyna} (動力週期)	0.011(s)	0.01(s)
	T_{design} (設計週期)	0.011(s)	0.01(s)
	R(結構系統韌性容量)	3	3
	R_a (結構系統容許韌性容量)	2.333	2.333



各方向地震力計算		X方向	Y方向
2. 最小設計水平總橫力	S_{aD} (工址設計水平譜加速度)	0.337	0.334
	F_u (系統折減係數)	1.088	1.083
	$(S_{aD}/F_u)_m$	0.305	0.304
	V (最小設計水平總橫力)	0.240	0.239
3. 避免最大考量地震崩塌之設計地震力	S_{aM} (工址最大水平譜加速度)	0.414	0.411
	F_{uM} (系統最大折減係數)	1.123	1.116
	$(S_{aM}/F_{uM})_m$	0.336	0.335
	V_M (最大考量地震水平總橫力)	0.264	0.263
4. 避免中小度地震降伏之設計地震力	V^* (中小度地震水平總橫力)	0.087	0.086
5. 層間相對位移地震力	V_{drift} (層間相對位移地震力)	0.079	0.079

各方向地震力計算		Z方向
6. 垂直地震力	D_{DL+SDL} (垂直自重變位)	0.000(cm)
	T_{ver} (垂直週期) $=2\pi(D_{DL+SDL}/g)^{0.5}$	0.004(s)
	$S_{aD,v}$ (垂直設計譜加速度係數)	0.150
	F_{uv} (垂直地震系統折減係數)	1.031
	$(S_{aD,v}/F_{uv})_m$	0.145
	V_{ZD} (垂直設計地震力)	0.114
	$S_{aM,v}$ (垂直最大加速度係數)	0.189
	$F_{uv,M}$ (垂直最大地震系統折減係數)	1.043
	V_{ZM} (避免最大考量垂直地震崩塌)	0.131
	V_{Z^*} (避免中小度垂直地震降伏)	0.039

地震力統整		X方向	Y方向
1. 水平地震力	$V_{design} = \max(V, V_M, V^*)$	0.264	0.263
2. 層間位移地震力	V_{drift}	0.079	0.079
地震力統整		Z方向	
3. 垂直地震力	$V_{z,Design} = \max(V_{ZD}, V_{ZM}, V_{Z^*})$	0.131	



意外扭矩放大係數

Floor	Load Case	δ_{max} (cm)	δ_{avg} (cm)	$A_x = (\delta_{max}/1.2 \delta_{avg})^2$	備註
PRF	EXP	0.002(節點 3)	0.002	0.696	
PRF	EYP	0.002(節點 18)	0.002	0.695	
PRF	EXN	0.002(節點 3)	0.002	0.850	X 最大值
PRF	EYN	0.002(節點 18)	0.002	0.855	Y 最大值
1F	EXP	0.001(節點 18)	0.001	0.789	
1F	EYP	0.001(節點 3)	0.001	0.791	
1F	EXN	0.001(節點 3)	0.001	0.783	
1F	EYN	0.001(節點 18)	0.001	0.785	

X 向最大意外扭矩放大係數 A_x 小於 1，故質心偏移比例取 $Ecc=0.05$ 進行分析

Y 向最大意外扭矩放大係數 A_x 小於 1，故質心偏移比例取 $Ecc=0.05$ 進行分析



樓層地震力

(單位 tf)

	EXP	EXP	EYP	EYP	EXN	EXN	EYN	EYN
	VX	VY	VX	VY	VX	VY	VX	VY
PRF	-0.11	0.00	0.00	-0.11	-0.11	0.00	0.00	-0.11
1F	-0.08	0.00	0.00	-0.08	-0.08	0.00	0.00	-0.08
SUM	-0.19	0.00	0.00	-0.19	-0.19	0.00	0.00	-0.19

樓層層間變位角

	U _x		U _y	
	EXP	EXN	EYP	EYN
PRF	0.003‰(C3-1)	0.003‰(D1)	0.003‰(C6-1)	0.003‰(D10)
1F	0.005‰(C6)	0.005‰(C3)	0.004‰(C3)	0.004‰(C6)



碰撞距離檢討

依建築物耐震設計規範，為避免地震時所引起的變形造成鄰棟建築物間的相互碰撞，建築物應自留設設計地震力作用下產生位移乘以 $0.6 \times 1.4 \times \alpha_y \times R_a$ 倍之距離。

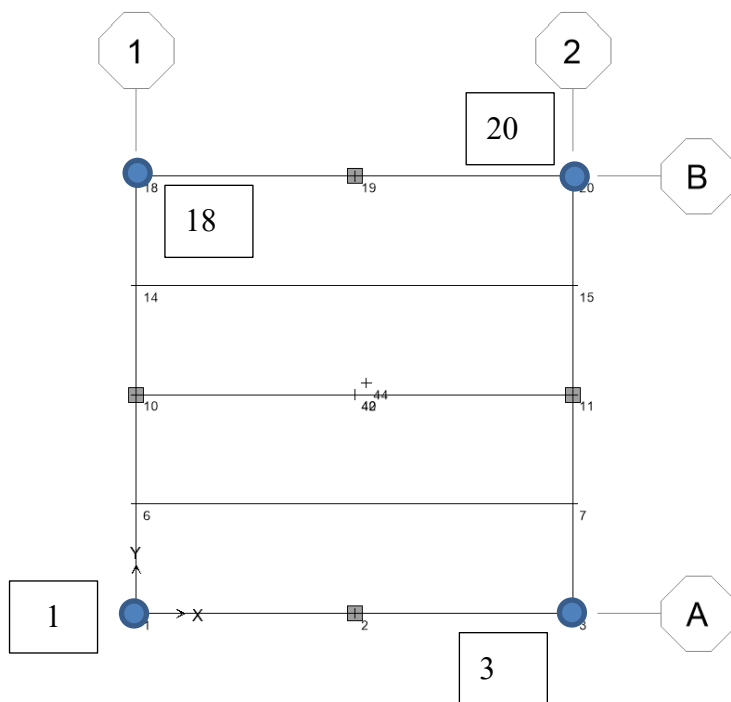

	節點 1		節點 3		節點 20		節點 18	
	X 向	Y 向	X 向	Y 向	X 向	Y 向	X 向	Y 向
475 年地震 側向位移 (cm)	0.002	0.002	0.002	0.002	0.002	0.002	0.002	0.002
安全 碰撞距離 (cm)	0.004	0.004	0.004	0.004	0.004	0.004	0.004	0.004
備註：位移放大倍數 X 向為 1.960，Y 向為 1.960								



4.3 設計風力

依據”建築物耐風設計規範及解說”，本建築基本設計風速為
每秒 37.5 公尺

封閉式建築主抗風系統屋頂風壓計算							
Enclosed Building Main Wind Force Resistance System Design Roof Pressure(TBC2006)							
Job:				Job No.			
				Made by: JWLI		Date: 2004/12/13	
1.1	Input data			尺寸			
	Exp=	C	V10=	37.5	m/sec	I=	1.1
	Z=	2.7	m	θ =	17	Degree	
	T=	0.03	sec	Beta=	0.02	B=	20 m
						L=	30 m
2.1	Basic Constant						
	Exposure=	C	α =	0.15	Zg=	300.00	m
	Design wind speed=	37.50	m/sec	Building width=	20.00	Ave. roof height=	2.70 m
	Do=	0.005	Damping ratio=	0.020			
2.2	Wind pressure						
	$K(h)=2.774(Z/Zg)^{2\alpha}$	h>5m	Average level	=	0.0000		
	$K(h)=2.774(5/Zg)^{2\alpha}$	h<5m		=	0.8122		
	$q(h)=0.06*K(z)*(IV_{10}(c))^2$			=	82.92	kg/m ²	
2.3	Roof design wind pressure						
	Direction	Width	Length	G(h)	Wind ward	Leeward	
					Cp	q(h)G(h)Cp	Cp
							q(h)G(h)Cp
	Wx	20	30	1.870	-0.46	-71	-0.7
	Wy	30	20	1.848	-0.70	-107	-107
2.4	Positive pressure under ROOF OVERHANG for main wind force resistance system						
	Direction	G(h)	Wind ward		Leeward		
			Cp	q(h)G(h)Cp	Cp	q(h)G(h)Cp	
	Wx	1.870	0.8	124	0.5	78	202
	Wy	1.848	0.8	123	0.5	77	199

Elevation View

Plan View

	WX	WX	WY	WY
	VX	VY	VX	VY
PRF	-0.81	0.00	0.00	-0.81
1F	-0.98	0.00	0.00	-0.98
SUM	-1.79	0.00	0.00	-1.79

X 向設計風力為 1.79tf，大於 X 向設計地震力 0.19tf
Y 向設計風力為 1.79tf，大於 Y 向設計地震力 0.19tf



4.4 載重組合

DL=Dead load (include member self weight)

LL=Live load

EXP,EXN=Code static seismic load x-direction (± 0.05 offset)

EYP,EYN=Code static seismic load y-direction (± 0.05 offset)

Ez=Code static vertical seismic load

$E_x = EXP \cdot EXN$

$E_y = EYP \cdot EYN$

W=Wind load

設計

1.4DL

1.2DL+1.6LL

1.2DL+1.0LL \pm 1.0E_x \pm 0.3E_z

1.2DL+1.0LL \pm 1.0E_y \pm 0.3E_z

1.2DL+1.0LL \pm 1.0E_z \pm 0.3E_x

1.2DL+1.0LL \pm 1.0E_z \pm 0.3E_y

0.9DL \pm 1.0E_x \pm 0.3E_z

0.9DL \pm 1.0E_y \pm 0.3E_z

0.9DL \pm 1.0E_z \pm 0.3E_x

0.9DL \pm 1.0E_z \pm 0.3E_y

1.2DL+1.0LL \pm 1.6W

0.9DL \pm 1.6W



	DL	SDL	LL	EXP	EYP	EXN	EYN	EZ	WX	WY
02RC01	1.400	1.400								
02RC02	1.200	1.200	1.600							
02RC03	1.200	1.200	1.000	1.000				0.300		
02RC04	1.200	1.200	1.000	1.000				-0.300		
02RC05	1.200	1.200	1.000		1.000			0.300		
02RC06	1.200	1.200	1.000		1.000			-0.300		
02RC07	1.200	1.200	1.000			1.000		0.300		
02RC08	1.200	1.200	1.000			1.000		-0.300		
02RC09	1.200	1.200	1.000				1.000	0.300		
02RC10	1.200	1.200	1.000				1.000	-0.300		
02RC11	1.200	1.200	1.000	-1.000				0.300		
02RC12	1.200	1.200	1.000	-1.000				-0.300		
02RC13	1.200	1.200	1.000		-1.000			0.300		
02RC14	1.200	1.200	1.000		-1.000			-0.300		
02RC15	1.200	1.200	1.000			-1.000		0.300		
02RC16	1.200	1.200	1.000			-1.000		-0.300		
02RC17	1.200	1.200	1.000				-1.000	0.300		
02RC18	1.200	1.200	1.000				-1.000	-0.300		
02RC19	1.200	1.200	1.000	0.300				1.000		
02RC20	1.200	1.200	1.000	0.300				-1.000		
02RC21	1.200	1.200	1.000		0.300			1.000		
02RC22	1.200	1.200	1.000		0.300			-1.000		
02RC23	1.200	1.200	1.000			0.300		1.000		
02RC24	1.200	1.200	1.000			0.300		-1.000		
02RC25	1.200	1.200	1.000				0.300	1.000		
02RC26	1.200	1.200	1.000				0.300	-1.000		
02RC27	1.200	1.200	1.000	-0.300				1.000		
02RC28	1.200	1.200	1.000	-0.300				-1.000		
02RC29	1.200	1.200	1.000		-0.300			1.000		
02RC30	1.200	1.200	1.000		-0.300			-1.000		
02RC31	1.200	1.200	1.000			-0.300		1.000		
02RC32	1.200	1.200	1.000			-0.300		-1.000		
02RC33	1.200	1.200	1.000				-0.300	1.000		
02RC34	1.200	1.200	1.000				-0.300	-1.000		
02RC35	0.900	0.900		1.000				0.300		
02RC36	0.900	0.900		1.000				-0.300		
02RC37	0.900	0.900			1.000			0.300		
02RC38	0.900	0.900			1.000			-0.300		
02RC39	0.900	0.900				1.000		0.300		
02RC40	0.900	0.900				1.000		-0.300		



02RC41	0.900	0.900					1.000	0.300		
02RC42	0.900	0.900					1.000	-0.300		
02RC43	0.900	0.900		-1.000				0.300		
02RC44	0.900	0.900		-1.000				-0.300		
02RC45	0.900	0.900			-1.000			0.300		
02RC46	0.900	0.900			-1.000			-0.300		
02RC47	0.900	0.900				-1.000		0.300		
02RC48	0.900	0.900				-1.000		-0.300		
02RC49	0.900	0.900					-1.000	0.300		
02RC50	0.900	0.900					-1.000	-0.300		
02RC51	0.900	0.900		0.300				1.000		
02RC52	0.900	0.900		0.300				-1.000		
02RC53	0.900	0.900			0.300			1.000		
02RC54	0.900	0.900			0.300			-1.000		
02RC55	0.900	0.900				0.300		1.000		
02RC56	0.900	0.900				0.300		-1.000		
02RC57	0.900	0.900					0.300	1.000		
02RC58	0.900	0.900					0.300	-1.000		
02RC59	0.900	0.900		-0.300				1.000		
02RC60	0.900	0.900		-0.300				-1.000		
02RC61	0.900	0.900			-0.300			1.000		
02RC62	0.900	0.900			-0.300			-1.000		
02RC63	0.900	0.900				-0.300		1.000		
02RC64	0.900	0.900				-0.300		-1.000		
02RC65	0.900	0.900					-0.300	1.000		
02RC66	0.900	0.900					-0.300	-1.000		
02RC67	1.200	1.200	1.000						1.600	
02RC68	1.200	1.200	1.000							1.600
02RC69	1.200	1.200	1.000						-1.600	
02RC70	1.200	1.200	1.000							-1.600
02RC71	0.900	0.900							1.600	
02RC72	0.900	0.900								1.600
02RC73	0.900	0.900							-1.600	
02RC74	0.900	0.900								-1.600



5.0 工作載重結構行為限制

A. 梁變形限制

靜載重加活載重 $L/240$

活載重 $L/360$

B. 地震力側向變形角限制

最大變形角 $5/1000$

C. 結構受風力側向加速度限制

最大加速度 $0.005g (0.05 \text{ m/sec}^2)$

6.0 設計規範

- (1) 建築技術規則, 內政部, 最新版。
- (2) 建築物耐震設計規範及解說, 內政部, 2011/07。
- (3) 建築物基礎構造設計規範, 內政部, 2001/10。
- (4) 混凝土結構設計規範, 內政部, 2011/07。
- (5) 建築物耐風設計規範及解說, 內政部, 2017/01。
- (6) 冷軋型鋼構造建築物結構設計規範及解說, 內政部, 2015/10
- (7) ACI 318-05。



7.0 結構分析程序

7.1 結構模型

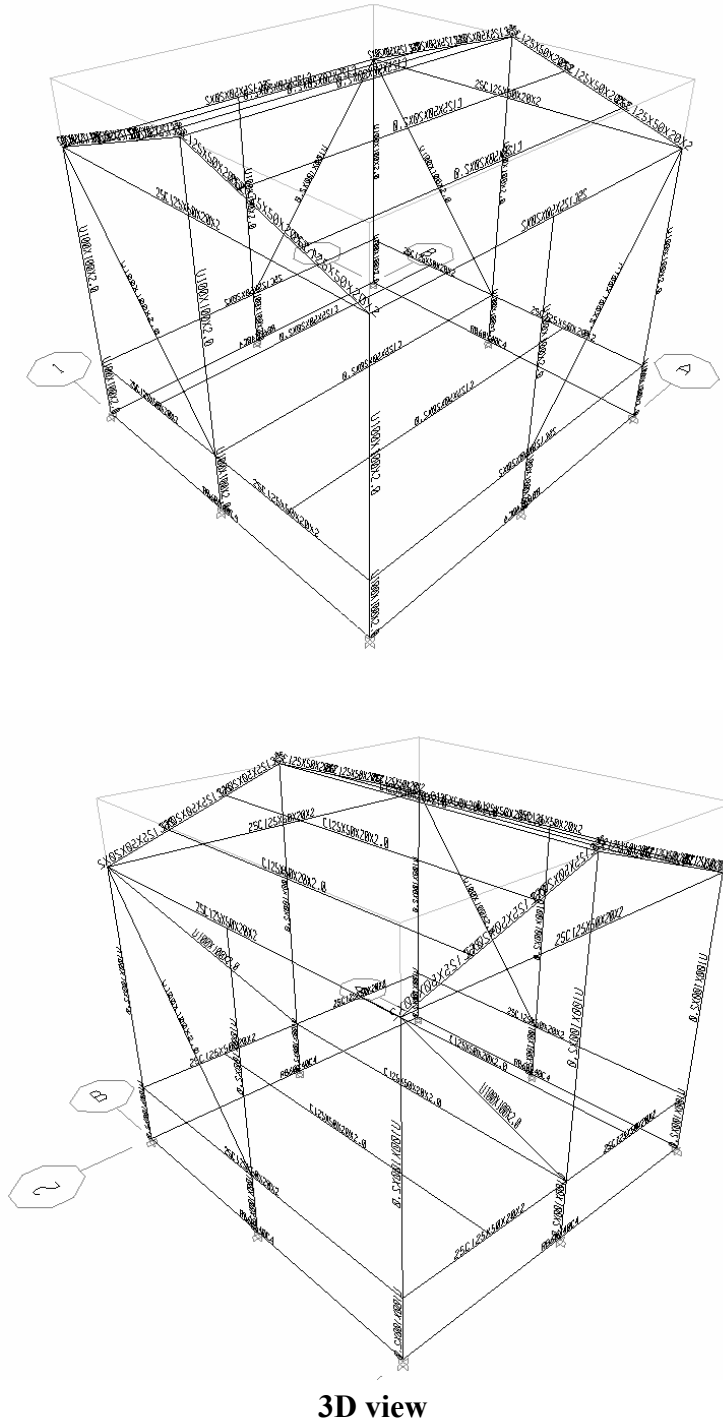

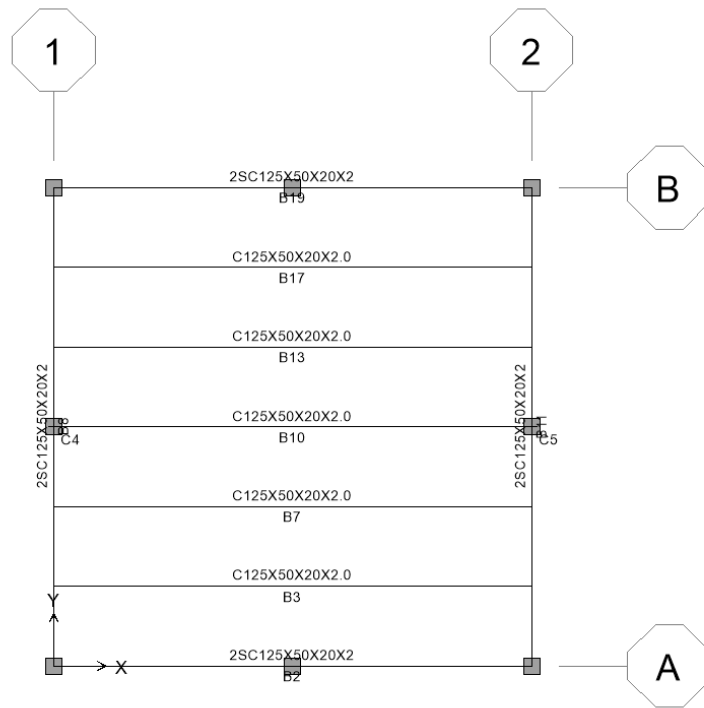

PRF plan

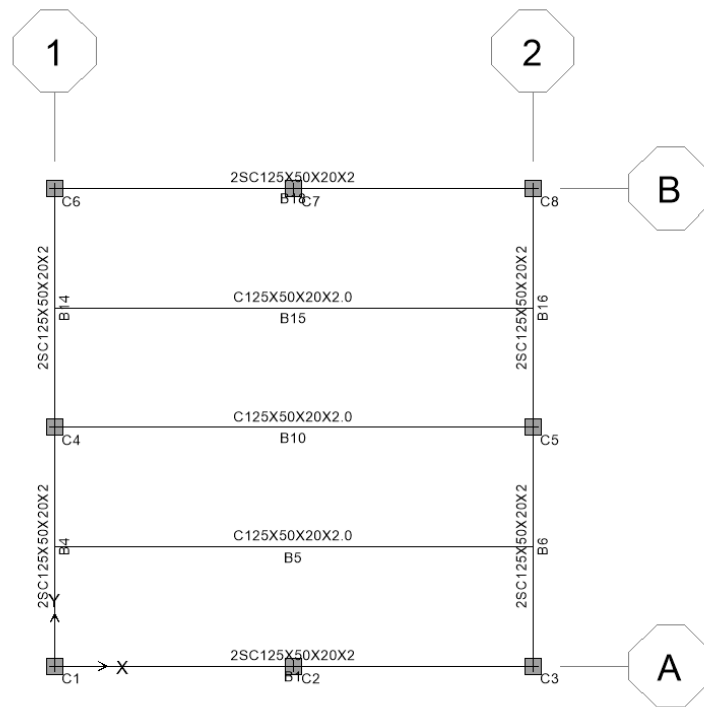

1F plan

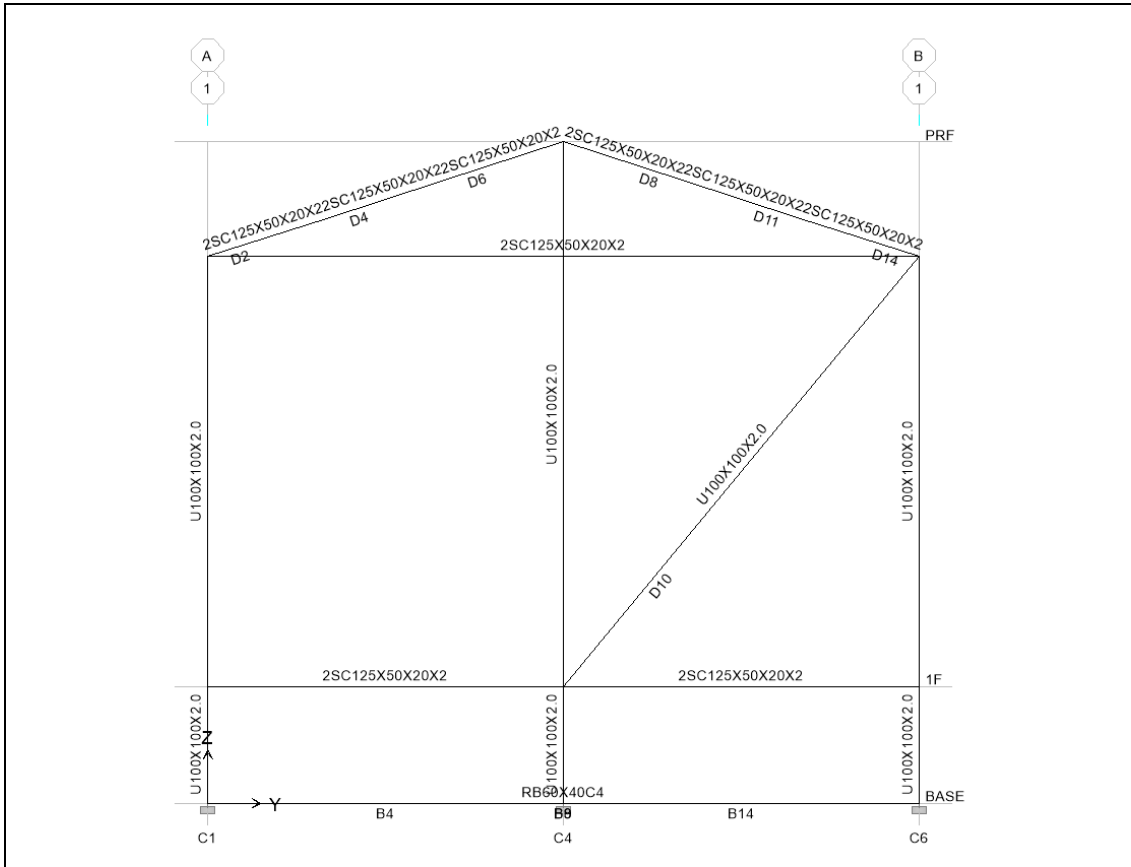

EL Line-1

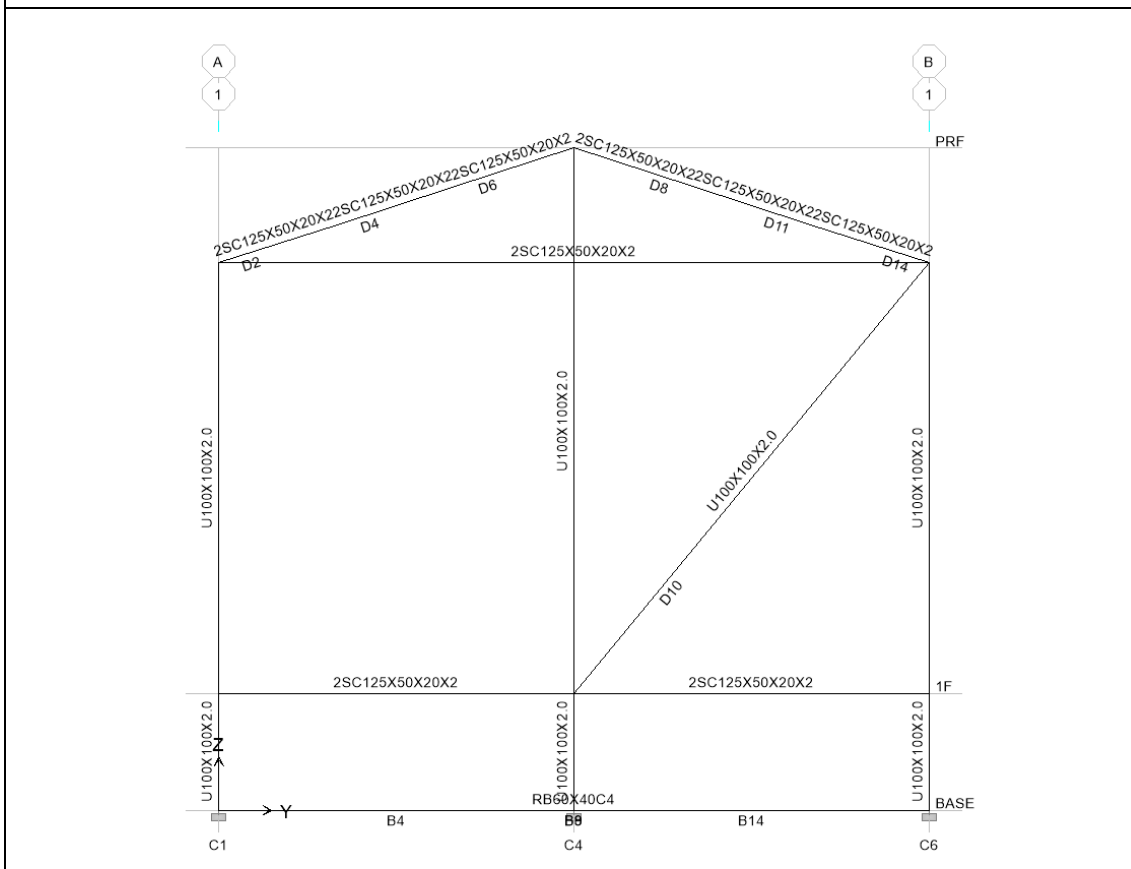

EL Line-2

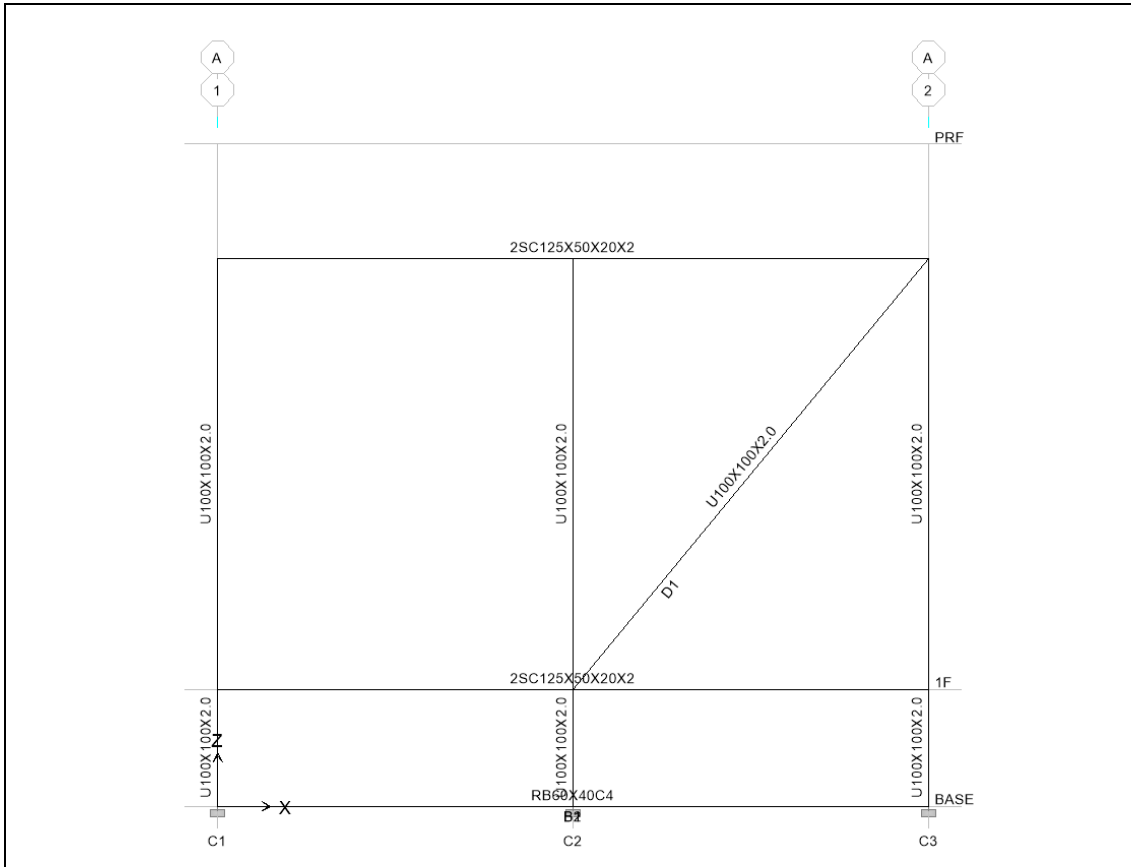

EL Line-A

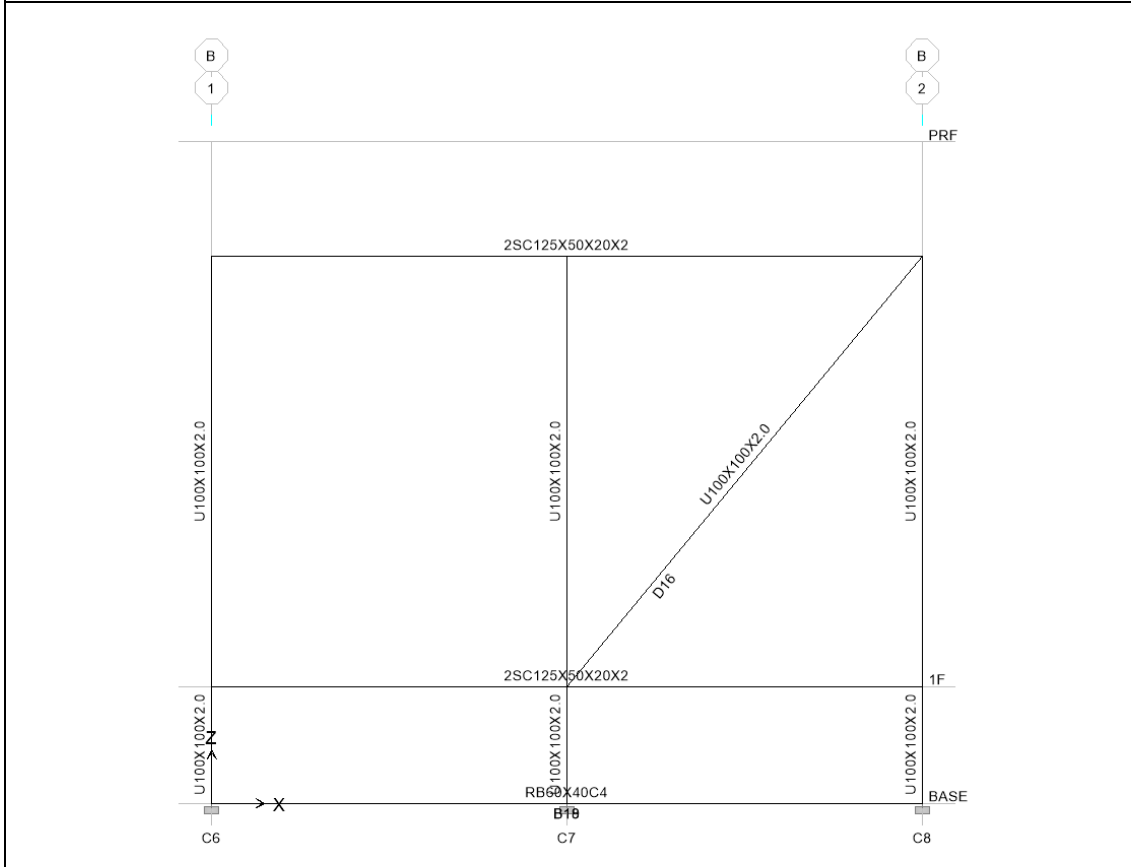

EL Line-B



斷面性質

C125x50x20x2.0

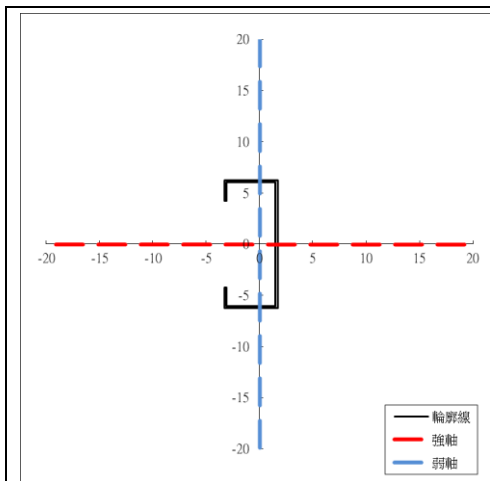

斷面積： $A= 5.140 \text{ (cm}^2\text{)}$

慣性矩： $I_x= 124.468 \text{ (cm}^4\text{)}$

$I_y= 19.025 \text{ (cm}^4\text{)}$

斷面模數： $S_x= 19.915 \text{ (cm}^3\text{)}$

$S_y= 5.776 \text{ (cm}^3\text{)}$

U100x100x2.0

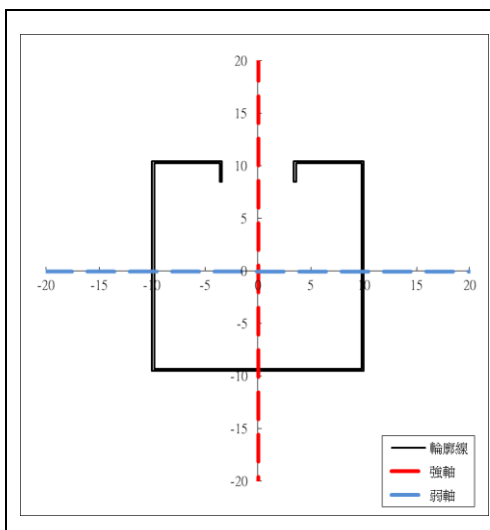

斷面積： $A= 15.200 \text{ (cm}^2\text{)}$

慣性矩： $I_x= 955.743 \text{ (cm}^4\text{)}$

$I_y= 1038.673 \text{ (cm}^4\text{)}$

斷面模數： $S_x= 91.334 \text{ (cm}^3\text{)}$

$S_y= 103.867 \text{ (cm}^3\text{)}$



2-C125x50x20x2.0

	<p>彈性係數：</p> $E = 2100000 \quad (\text{kgf/cm}^2)$ <p>斷面積：</p> $A = \frac{\sum E \cdot A}{E} = 10.280 \quad (\text{cm}^2)$ <p>慣性矩：</p> $I_x = \frac{\sum E \cdot I_x}{E} = 248.937 \quad (\text{cm}^4)$ $I_y = \frac{\sum E \cdot I_y}{E} = 38.050 \quad (\text{cm}^4)$ <p>斷面模數：</p> $S_x = \frac{\sum E \cdot I_x}{E_i \cdot y_i} = 39.830 \quad (\text{cm}^3)$ $S_y = \frac{\sum E \cdot I_y}{E_i \cdot x_i} = 11.552 \quad (\text{cm}^3)$
--	--

7.2 模態分析

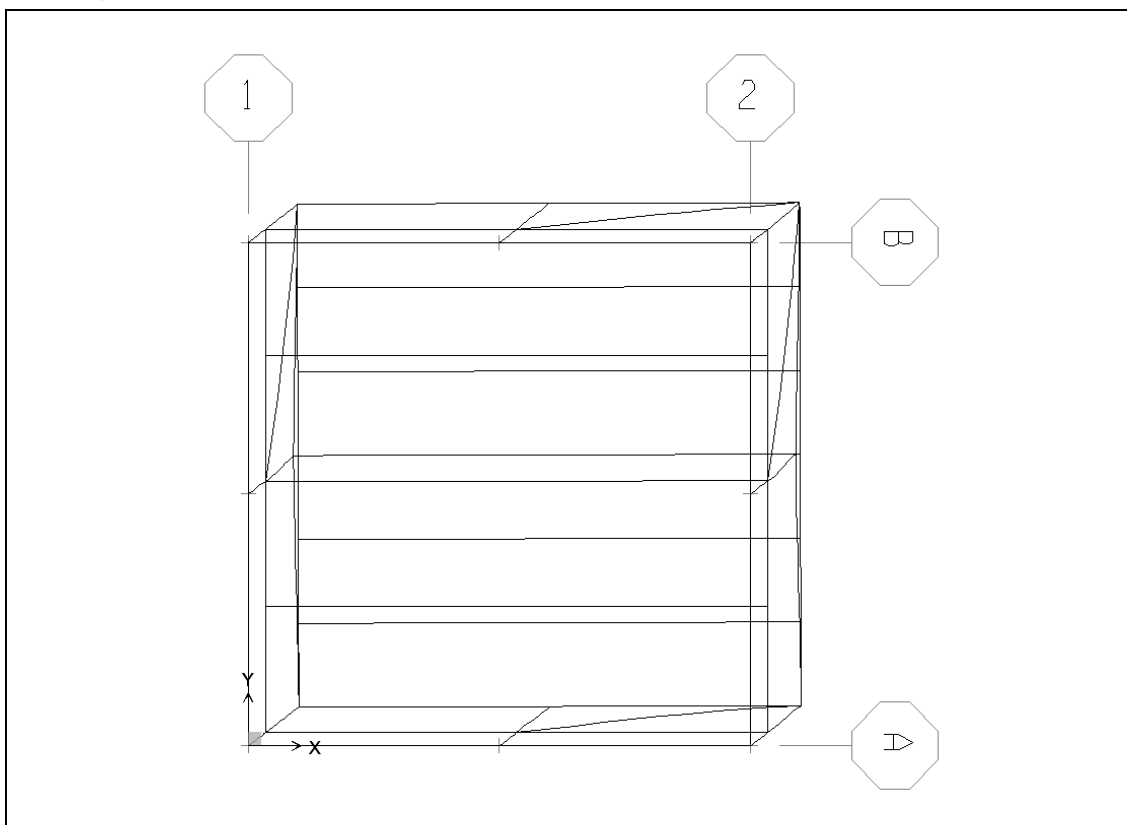

X 向位移模態 T=0.011 (Mode 1)

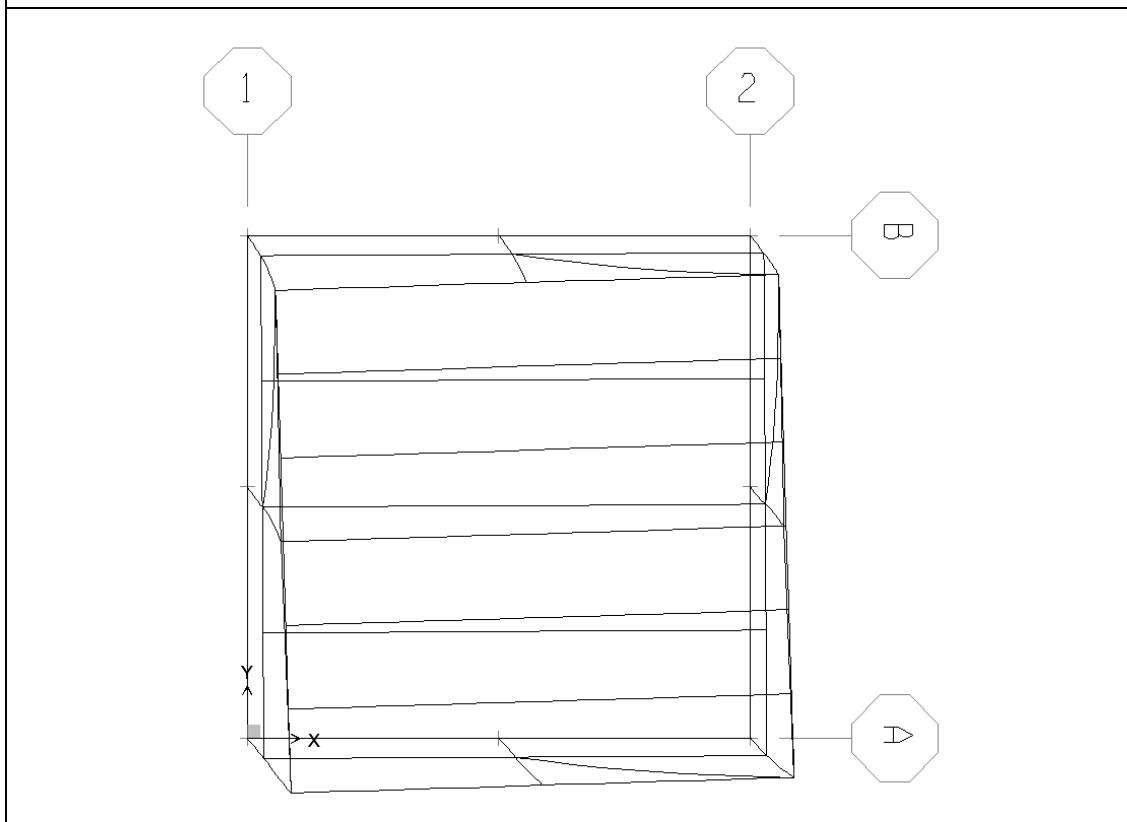

Y 向位移模態 T=0.010 (Mode 2)

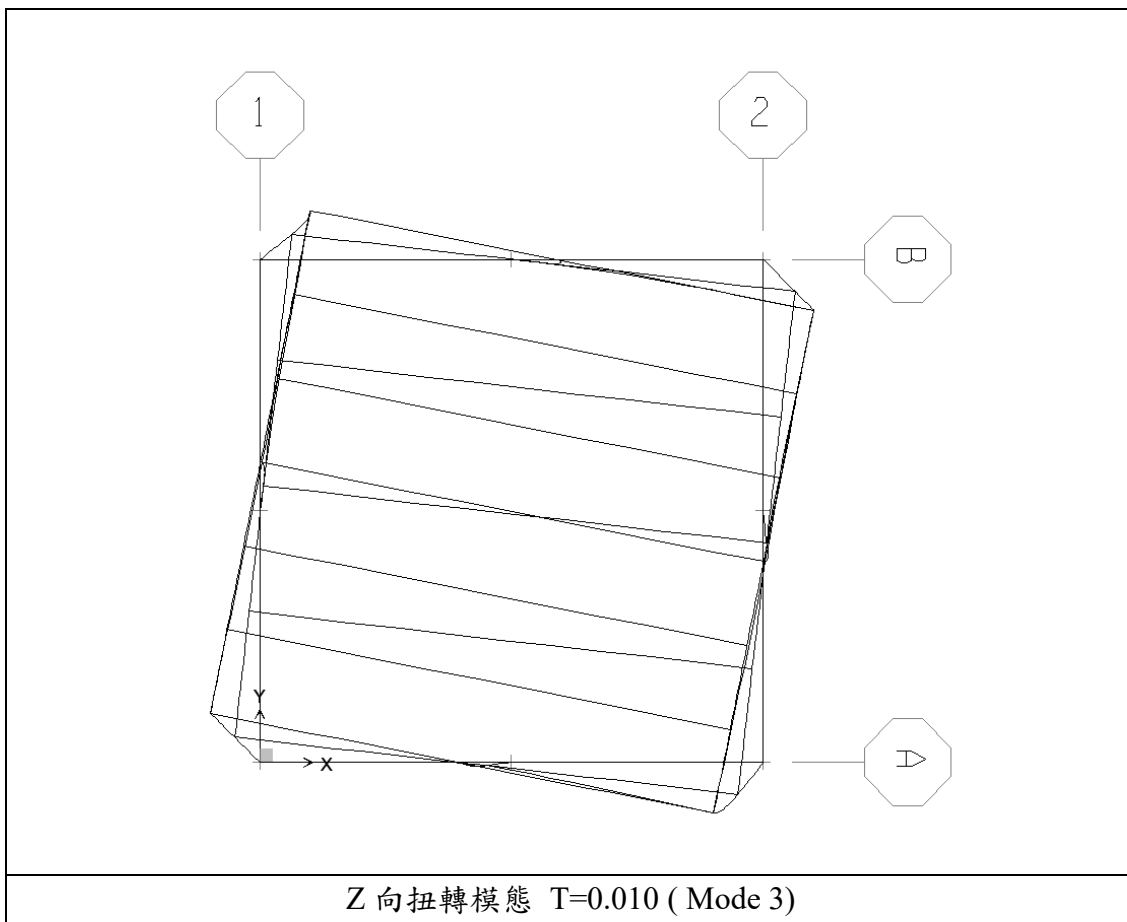

有效累積振態質量

Mode	Period	UX	UY	RZ	SumUX	SumUY	SumRZ	Remark
1	0.011	47.693	28.476	0.001	47.693	28.476	0.001	X-Dir
2	0.010	31.103	50.588	0.299	78.796	79.064	0.300	Y-Dir
3	0.010	0.969	1.023	93.595	79.764	80.086	93.895	Z-Tor
4	0.006	15.585	8.077	0.063	95.350	88.163	93.959	
5	0.006	4.483	11.599	1.706	99.833	99.763	95.665	
6	0.005	0.167	0.237	4.335	100.000	100.000	100.000	



7.2 鋼結構設計：

根據鋼構造建築物鋼結構設計技術規範，鋼結構極限設計法之相關規定，對稱構材承受彎矩及軸力交互作用時，須滿足公式(8.2-1a)或(8.2-1b)之規定。

當 $\frac{P_u}{\phi P_n} \geq 0.2$ 時

$$\frac{P_u}{\phi P_n} + \frac{8}{9} \left[\frac{M_{ux}}{\phi_b M_{nx}} + \frac{M_{uy}}{\phi_b M_{ny}} \right] \leq 1.0 \quad (8.2-1a)$$

當 $\frac{P_u}{\phi P_n} < 0.2$ 時

$$\frac{P_u}{2\phi P_n} + \left[\frac{M_{ux}}{\phi_b M_{nx}} + \frac{M_{uy}}{\phi_b M_{ny}} \right] \leq 1.0 \quad (8.2-1b)$$

其中

P_u = 所需之軸拉力或軸壓力強度

P_n = 標稱抗拉強度或標稱抗壓強度

M_u = 所需之撓曲強度

M_n = 標稱之撓曲強度

x = 強軸

y = 弱軸

ϕ = 軸力載重下之強度折減係數

ϕ_b = 撓曲載重下之強度折減係數

分析模型各桿件的應力比皆小於1.....OK!

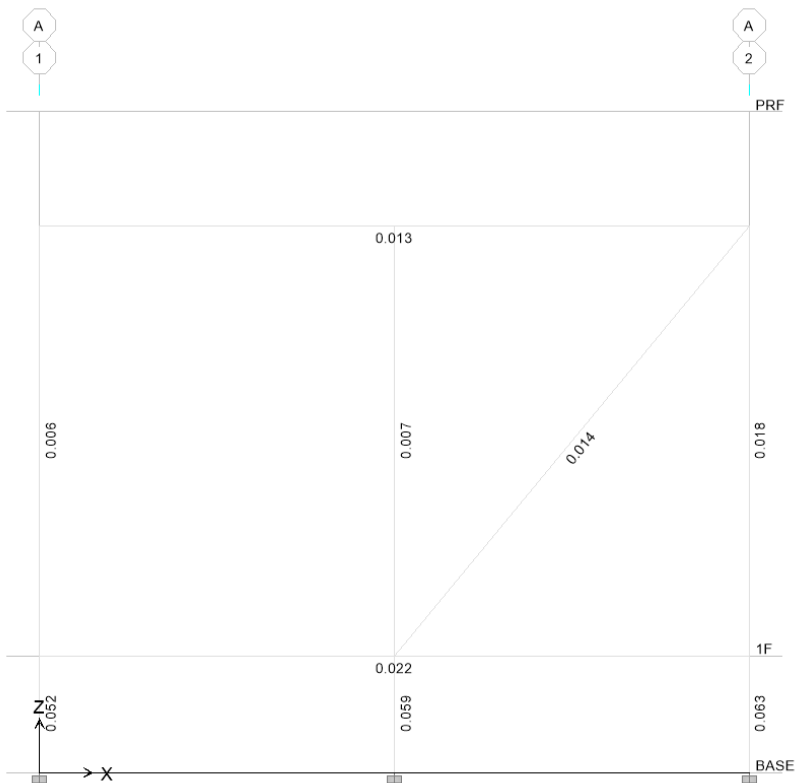
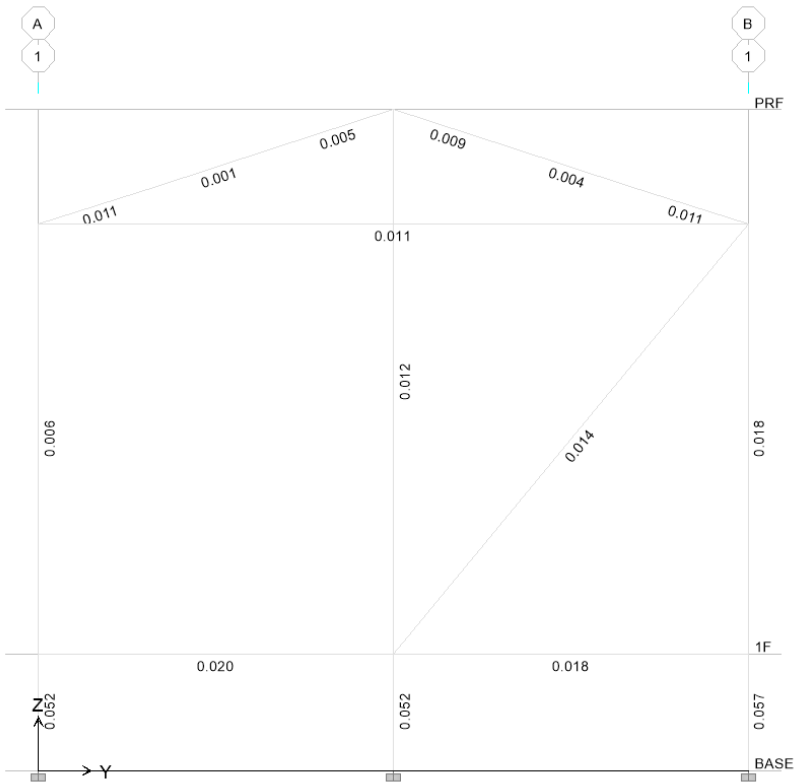

9.0 基礎設計 / Foundation Design

9.1 基礎設計說明

本案基礎設計採 CSI 公司之 2-D 分析軟體”SAFE V8.01”，分析元素包含基礎版、及地梁，版元素下方承受地下水壓上舉水浮力，版元素上方則於柱位置處承受結構傳遞之垂直載重，包含靜載重、活載重及地震力等。將基礎為一柔性體，應用土壤彈簧（Soil Spring）之觀念，將土壤模擬成無受拉彈簧，同時合併基礎地梁、版之勁度進行分析並設計。

9.1.1 分析基本資料

依據鄰近地質鑽探報告，各設計數據如下：

地盤垂直反力係數	$K_v = 1000(\text{tf}/\text{m}^3)$
常時水位(WAN)	GL -10m
高水位(WAH)	GL -7m
土壤容許乘載力	$q_a > 10 (\text{tf}/\text{m}^2)$

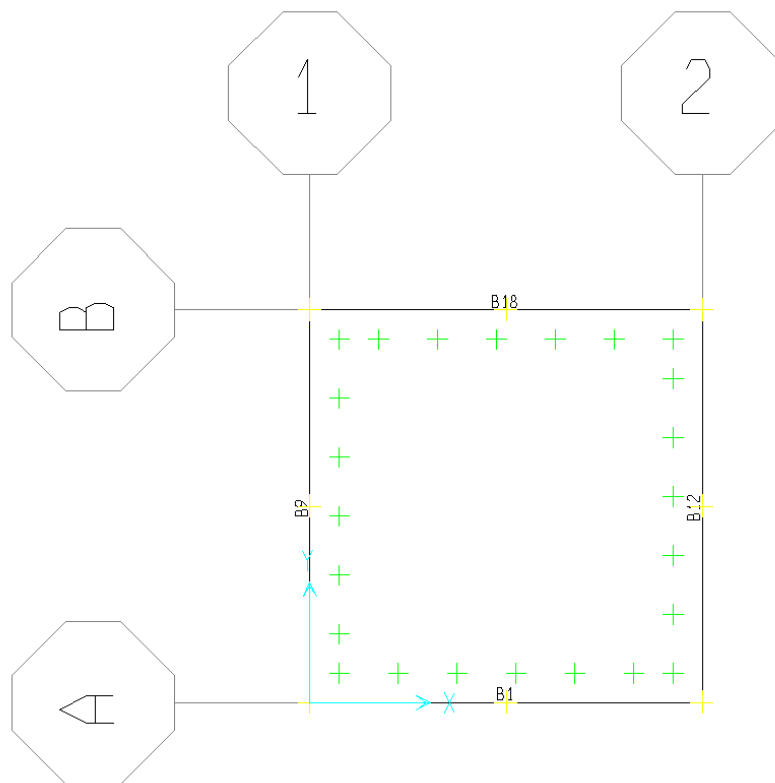

基礎結構平面圖



9.1.2 基礎設計載重組合

地震力分析採用法規靜力地震力，將上部結構桿件力傳至基礎。配筋設計採用設計地震力之 $1.0\alpha y$ 倍作為設計載重。分析及配筋設計之載重組合如下：

DL：靜載重(包含自重)

LL：活載重

E：法規地震載重 (EXP、EXN、EYP、EYN)

EXP、EXN：X 向法規靜力地震載重(含正負 5% 質心偏移，P 為正，N 為負)

EYP、EYN：Y 向法規靜力地震載重(含正負 5% 質心偏移，P 為正，N 為負)

WA：水浮力 (WAH、WAN)

WAH：高水位時之水浮力

WAN：常時水位之水浮力

檢核(乘載力檢核)

$$1.0DL+1.0WA$$

$$1.0DL+1.0LL+1.0WA$$

$$1.0DL+1.0LL\pm 1.0E+1.0WA$$

設計

$$1.4DL+1.4WA$$

$$1.2DL+1.6LL+1.2WA$$

$$1.2DL+1.0LL\pm 1.4E$$

$$0.9DL\pm 1.4E$$



	DL	SDL	LL	EXP	EYP	EXN	EYN	WAH	WAN	備註
BASE01	1.000	1.000						1.000		檢核(乘載力檢核)
BASE02	1.000	1.000							1.000	
BASE03	1.000	1.000	1.000					1.000		
BASE04	1.000	1.000	1.000						1.000	
BASE05	1.000	1.000	1.000	1.000				1.000		
BASE06	1.000	1.000	1.000	1.000					1.000	
BASE07	1.000	1.000	1.000		1.000			1.000		
BASE08	1.000	1.000	1.000		1.000				1.000	
BASE09	1.000	1.000	1.000			1.000		1.000		
BASE10	1.000	1.000	1.000			1.000			1.000	
BASE11	1.000	1.000	1.000				1.000	1.000		
BASE12	1.000	1.000	1.000				1.000		1.000	
BASE13	1.000	1.000	1.000	-1.000				1.000		
BASE14	1.000	1.000	1.000	-1.000					1.000	
BASE15	1.000	1.000	1.000		-1.000			1.000		
BASE16	1.000	1.000	1.000		-1.000				1.000	
BASE17	1.000	1.000	1.000			-1.000		1.000		
BASE18	1.000	1.000	1.000			-1.000			1.000	
BASE19	1.000	1.000	1.000				-1.000	1.000		
BASE20	1.000	1.000	1.000				-1.000		1.000	
BASE21	1.400	1.400						1.400		設計
BASE22	1.400	1.400							1.400	
BASE23	1.200	1.200	1.600					1.200		
BASE24	1.200	1.200	1.600						1.200	
BASE25	1.200	1.200	1.000	1.400						
BASE26	1.200	1.200	1.000		1.400					
BASE27	1.200	1.200	1.000			1.400				
BASE28	1.200	1.200	1.000				1.400			
BASE29	1.200	1.200	1.000	-1.400						
BASE30	1.200	1.200	1.000		-1.400					
BASE31	1.200	1.200	1.000			-1.400				
BASE32	1.200	1.200	1.000				-1.400			
BASE33	0.900	0.900		1.400						
BASE34	0.900	0.900			1.400					
BASE35	0.900	0.900				1.400				
BASE36	0.900	0.900					1.400			



BASE37	0.900	0.900		-1.400					
BASE38	0.900	0.900			-1.400				
BASE39	0.900	0.900				-1.400			
BASE40	0.900	0.900					-1.400		

9.2 基礎分析

9.2.1 分析基本資料

1. 容許承载力檢核：

承载力檢核考慮載重組合為 BASE04

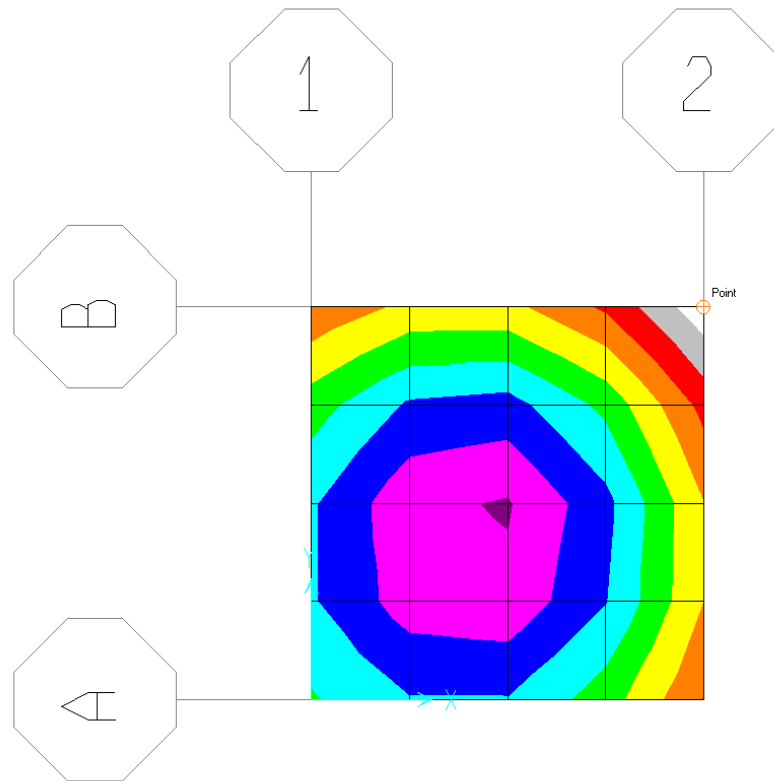

土壤最大反力為 $2.17(\text{tf}/\text{m}^2) < q_a = 10(\text{tf}/\text{m}^2) \dots \text{OK}$



2. 角變量檢核：

載重組合	基礎最大角變量 η	最大角變量桿件	檢核角變量 η
BASE01	1 /16285861	B12	$\eta < 1/500 \dots OK$
BASE02	1 /16285861	B12	$\eta < 1/500 \dots OK$
BASE03	1 /16285861	B12	$\eta < 1/500 \dots OK$
BASE04	1 /16285861	B12	$\eta < 1/500 \dots OK$
BASE05	1 /3970940	B12	$\eta < 1/333 \dots OK$
BASE06	1 /3970940	B12	$\eta < 1/333 \dots OK$
BASE07	1 /4004440	B18	$\eta < 1/333 \dots OK$
BASE08	1 /4004440	B18	$\eta < 1/333 \dots OK$
BASE09	1 /4030147	B12	$\eta < 1/333 \dots OK$
BASE10	1 /4030147	B12	$\eta < 1/333 \dots OK$
BASE11	1 /3944781	B18	$\eta < 1/333 \dots OK$
BASE12	1 /3944781	B18	$\eta < 1/333 \dots OK$
BASE13	1 /7744364	B9	$\eta < 1/333 \dots OK$
BASE14	1 /7744364	B9	$\eta < 1/333 \dots OK$
BASE15	1 /7875996	B1	$\eta < 1/333 \dots OK$
BASE16	1 /7875996	B1	$\eta < 1/333 \dots OK$
BASE17	1 /7976060	B9	$\eta < 1/333 \dots OK$
BASE18	1 /7976060	B9	$\eta < 1/333 \dots OK$
BASE19	1 /7649994	B1	$\eta < 1/333 \dots OK$
BASE20	1 /7649994	B1	$\eta < 1/333 \dots OK$



3. 基礎最大沉陷量檢核

載重組合	基礎最大沉陷變位 δ (cm)	最大沉陷點	檢核沉陷變位
BASE01	-0.217	20	$\delta < 5.000(\text{cm}) \dots \text{OK}$
BASE02	-0.217	20	$\delta < 5.000(\text{cm}) \dots \text{OK}$
BASE03	-0.217	20	$\delta < 5.000(\text{cm}) \dots \text{OK}$
BASE04	-0.217	20	$\delta < 5.000(\text{cm}) \dots \text{OK}$
BASE05	-0.323	20	$\delta < 7.500(\text{cm}) \dots \text{OK}$
BASE06	-0.323	20	$\delta < 7.500(\text{cm}) \dots \text{OK}$
BASE07	-0.223	20	$\delta < 7.500(\text{cm}) \dots \text{OK}$
BASE08	-0.223	20	$\delta < 7.500(\text{cm}) \dots \text{OK}$
BASE09	-0.223	20	$\delta < 7.500(\text{cm}) \dots \text{OK}$
BASE10	-0.223	20	$\delta < 7.500(\text{cm}) \dots \text{OK}$
BASE11	-0.223	20	$\delta < 7.500(\text{cm}) \dots \text{OK}$
BASE12	-0.223	20	$\delta < 7.500(\text{cm}) \dots \text{OK}$
BASE13	-0.121	18	$\delta < 7.500(\text{cm}) \dots \text{OK}$
BASE14	-0.121	18	$\delta < 7.500(\text{cm}) \dots \text{OK}$
BASE15	-0.221	3	$\delta < 7.500(\text{cm}) \dots \text{OK}$
BASE16	-0.221	3	$\delta < 7.500(\text{cm}) \dots \text{OK}$
BASE17	-0.221	18	$\delta < 7.500(\text{cm}) \dots \text{OK}$
BASE18	-0.221	18	$\delta < 7.500(\text{cm}) \dots \text{OK}$
BASE19	-0.221	3	$\delta < 7.500(\text{cm}) \dots \text{OK}$
BASE20	-0.221	3	$\delta < 7.500(\text{cm}) \dots \text{OK}$



9.3 基礎結構設計

1. 材料強度

混凝土抗壓強度： 280 kgf/cm^2

鋼筋降伏強度： 2800 kgf/cm^2 (#3 及以下)

4200 kgf/cm^2 (#4 及以上)

2. 地樑設計

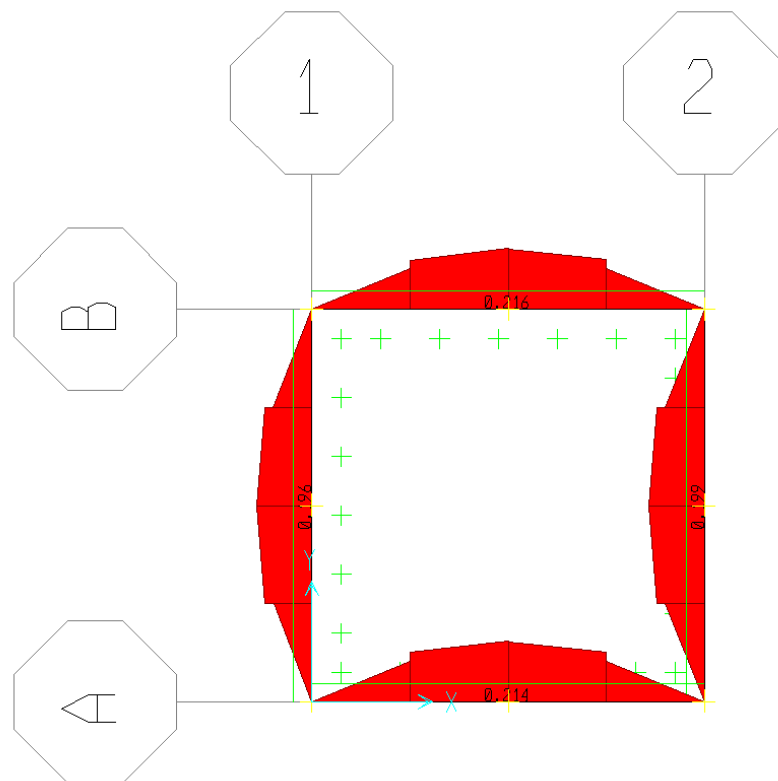



3. 基版 X 向鋼筋需求

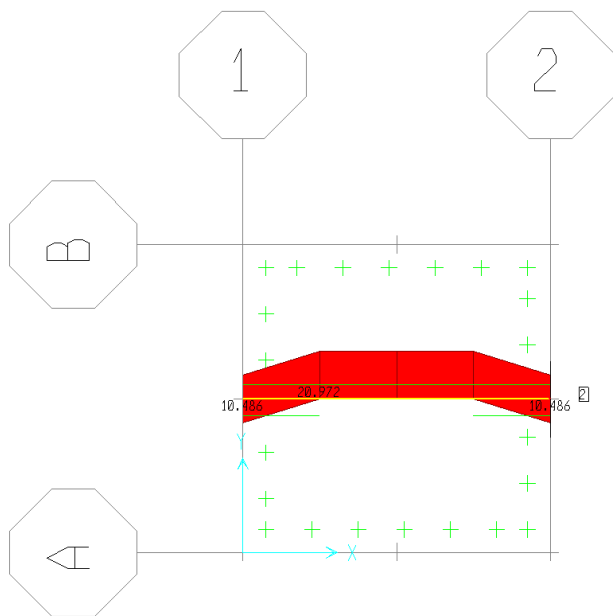

4. 基版 Y 向鋼筋需求

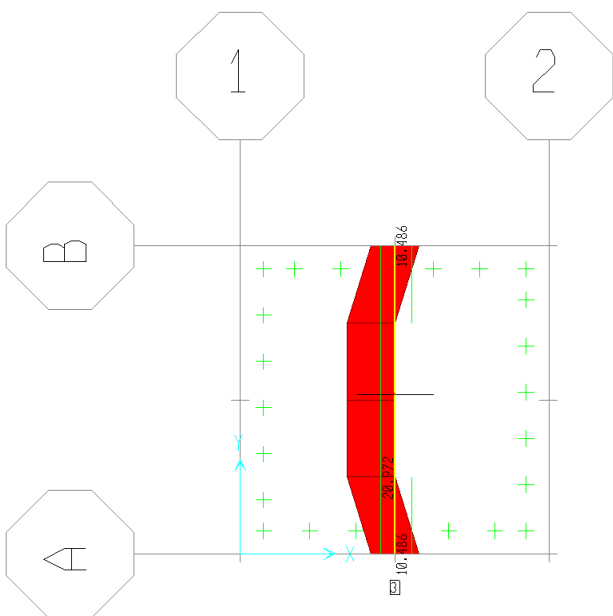



附錄

COMBO 'DCON22' LOAD 'SDL' SF 1.4
COMBO 'DCON22' LOAD 'TL' SF 1
COMBO 'DCON22' LOAD 'EYN' SF -1.5
COMBO 'DCON23' TYPE 'ADD'
COMBO 'DCON23' LOAD 'DL' SF 1.4
COMBO 'DCON23' LOAD 'SDL' SF 1.4
COMBO 'DCON23' LOAD 'EXP' SF 1.5
COMBO 'DCON24' TYPE 'ADD'
COMBO 'DCON24' LOAD 'DL' SF 1.4
COMBO 'DCON24' LOAD 'SDL' SF 1.4
COMBO 'DCON24' LOAD 'EXP' SF -1.5
COMBO 'DCON25' TYPE 'ADD'
COMBO 'DCON25' LOAD 'DL' SF 1.4
COMBO 'DCON25' LOAD 'SDL' SF 1.4
COMBO 'DCON25' LOAD 'EYP' SF 1.5
COMBO 'DCON26' TYPE 'ADD'
COMBO 'DCON26' LOAD 'DL' SF 1.4
COMBO 'DCON26' LOAD 'SDL' SF 1.4
COMBO 'DCON26' LOAD 'EYP' SF -1.5
COMBO 'DCON27' TYPE 'ADD'
COMBO 'DCON27' LOAD 'EYN' SF 1.4
COMBO 'DCON27' LOAD 'EXN' SF 1.5
COMBO 'DCON28' TYPE 'ADD'
COMBO 'DCON28' LOAD 'DL' SF 1.4
COMBO 'DCON28' LOAD 'SDL' SF 1.4
COMBO 'DCON28' LOAD 'EXN' SF -1.5
COMBO 'DCON29' TYPE 'ADD'
COMBO 'DCON29' LOAD 'DL' SF 1.4
COMBO 'DCON29' LOAD 'SDL' SF 1.4
COMBO 'DCON29' LOAD 'EYN' SF 1.5
COMBO 'DCON30' TYPE 'ADD'
COMBO 'DCON30' LOAD 'DL' SF 1.4
COMBO 'DCON30' LOAD 'SDL' SF 1.4
COMBO 'DCON30' LOAD 'EYN' SF -1.5
COMBO 'DCON31' TYPE 'ADD'
COMBO 'DCON31' LOAD 'DL' SF 0.7
COMBO 'DCON31' LOAD 'SDL' SF 0.7
COMBO 'DCON31' LOAD 'EXP' SF 1.5
COMBO 'DCON32' TYPE 'ADD'
COMBO 'DCON32' LOAD 'DL' SF 0.7
COMBO 'DCON32' LOAD 'SDL' SF 0.7
COMBO 'DCON32' LOAD 'EXP' SF -1.5
COMBO 'DCON33' TYPE 'ADD'
COMBO 'DCON33' LOAD 'DL' SF 0.7
COMBO 'DCON33' LOAD 'SDL' SF 0.7
COMBO 'DCON34' TYPE 'ADD'
COMBO 'DCON34' LOAD 'DL' SF 0.7
COMBO 'DCON34' LOAD 'SDL' SF 0.7
COMBO 'DCON34' LOAD 'EYP' SF -1.5
COMBO 'DCON35' TYPE 'ADD'
COMBO 'DCON35' LOAD 'DL' SF 0.7
COMBO 'DCON35' LOAD 'SDL' SF 0.7
COMBO 'DCON35' LOAD 'EXN' SF 1.5
COMBO 'DCON36' TYPE 'ADD'
COMBO 'DCON36' LOAD 'DL' SF 0.7
COMBO 'DCON36' LOAD 'EXN' SF -1.5
COMBO 'DCON37' TYPE 'ADD'
COMBO 'DCON37' LOAD 'DL' SF 0.7
COMBO 'DCON37' LOAD 'EYN' SF 1.5
COMBO 'DCON38' TYPE 'ADD'
COMBO 'DCON38' LOAD 'DL' SF 0.7
COMBO 'DCON38' LOAD 'SDL' SF 0.7
COMBO 'DCON38' LOAD 'EYN' SF -1.5

STEEL DESIGN PREFERENCES

STEELREFERENCE CODE 'AS318-02' THIDESGN 'EVERYSTP' FRAME TYPE 'MOMENT FRAME'
STEELREFERENCE PHIBLRFD 0.9 PHICLRFD 0.85 PHITLRFD 0.9 PHIVLRFD 0.9 PHICANGLELRFD 0.9
STEELREFERENCE PHIBLRFD 0.9 PHICLRFD 0.85 PHITLRFD 0.9 PHIVLRFD 0.9 PHICANGLELRFD 0.9
STEELREFERENCE CONSIDERDEFLECTION 'NO' RELATIVEDEFLECTION 'RATIO'
STEELREFERENCE DLDEFLECTIONLIMIT 120 SLDEFLECTIONLIMIT 120 LDEFLECTIONLIMIT 360 TLDEFLECTIONLIMIT 240 TLMCDEFLECTIONLIMIT
STEELREFERENCE DLDEFLECTIONLIMITABS 2.54 SLDEFLECTIONLIMITABS 2.54 LDEFLECTIONLIMITABS 2.54 TLDEFLECTIONLIMITABS 2.54
STEELREFERENCE CALCULATECAMBER 'NO' PERCENTCAMBERWDL 1 CAMBERRELMAXLMT 180 CAMBERNORELMT 1.905
STEELREFERENCE CAMBERABSMAXLMT 10.16 CAMBERINTERVAL 0.635 CAMBERGROUNDDOWN 'YES'
STEELREFERENCE PATTERNLFL 0.75 MAXITERATION 1 SRLIMIT 1.05

CONCRETE DESIGN PREFERENCES

CONCRETEREFERENCE CODE 'AC318-02' THIDESGN 'EVERYSTP' CONSIDERMINCECENTRICITY 'YES'
CONCRETEREFERENCE NUMINTERCURVES 24 NUMITERPOINTS 11 PATTERNLFL 0.75 UFLIMIT 1
CONCRETEREFERENCE SD 'D' PHITENSIONCTRL 0.9 PHICOMPRESSIONCTRLTIED 0.65 PHICOMPRESSIONCTRLSPRAL 0.7 PHISHORTCURVES

COMPOSITE DESIGN PREFERENCES

COMPOSITEREFERENCE CODE 'AS318-02'
COMPOSITEREFERENCE PHIB 0.9 PHIBCN 0.9 PHIBCN 0.85 PHIBCFE 0.9 PHIBCFP 0.85 PHIBV 0.9
COMPOSITEREFERENCE SHORRED 'NO' %MIDDLELARGE 70 PATTERNLFL 0.75 SRLIMIT 1 SINGLESEGMENT 'NO' STUDINCREASEFACTOR 1
COMPOSITEREFERENCE DLIMIT 0.9 SLIMIT 240 LLIMIT 360 TLIMIT 240 CRETEFACTOR 1
COMPOSITEREFERENCE %DLCAMBER 100 CAMBERIGNORE 1.905 CAMBERABSMAX 10.16 CAMBERRELMAX 180 CAMBERINTERVAL 0.635
COMPOSITEREFERENCE %VIBLL 25 CONSIDERFREQ 'NO' MINFREQ 8 CONSIDERDAMP 'NO' %INHERENTDAMP 4
COMPOSITEREFERENCE OPTIMIZEPRICE 'NO' CONNECTORPRICE 0 CAMBERPRICE 0

WALL DESIGN PREFERENCES

WALLREFERENCE CODE 'UBC97' THIDESGN 'EVERYSTP'
WALLREFERENCE REBARUNITS 'm2' REBARLENGTHUNITS 'm2/R'
WALLREFERENCE PHIB 0.9 PHIBV 0.85 PHIBVS 0.6 PMAFACTOR 0.8
WALLREFERENCE NUMLAYS 24 NUMSPORTS 11
WALLREFERENCE PTMAX 0.06 PCMAX 0.04 PMAAX 0.02 IPMIN 0.0025
WALLREFERENCE UFLIMIT 0.95

5 DIMENSION LINES

5 LOG

START COMMENTS

ETABS Display 9.5.0 File imported from E:\WORK\2022\2208A\MODEL\ETABS\SC1-1\220804\2208A-SC1-1-220804-001.SET at 2022/8/4 上午 11:12:12
ETABS Nonlinear 9.5.0 File saved as E:\WORK\2022\2208A\MODEL\ETABS\SC1-1\220804\2208A-SC1-1-220804-001.EDB at 2022/8/4 上午 11:22:48
ETABS Nonlinear 9.5.0 File saved as E:\WORK\2022\2208A\MODEL\ETABS\SC1-1\220804\2208A-SC1-1-220804-001.EDB at 2022/8/4 下午 05:39:27
ETABS Nonlinear 9.5.0 File saved as E:\WORK\2022\2208A\MODEL\ETABS\SC1-1\220804\2208A-SC1-1-220804-001.EDB at 2022/8/4 下午 05:40:26
ETABS Nonlinear 9.5.0 File saved as E:\WORK\2022\2208A\MODEL\ETABS\SC1-1\220804\2208A-SC1-1-220804-001.EDB at 2022/8/4 下午 05:41:18
ETABS Nonlinear 9.5.0 File saved as E:\WORK\2022\2208A\MODEL\ETABS\SC1-1\220804\2208A-SC1-1-220804-001.EDB at 2022/8/4 下午 05:42:28
ETABS Nonlinear 9.5.0 File saved as E:\WORK\2022\2208A\MODEL\ETABS\SC1-1\220804\2208A-SC1-1-220804-001.EDB at 2022/8/4 下午 05:44:15
ETABS Nonlinear 9.5.0 File saved as E:\WORK\2022\2208A\MODEL\ETABS\SC1-1\220804\2208A-SC1-1-220804-001.EDB at 2022/8/4 下午 05:47:36
ETABS Nonlinear 9.5.0 File saved as E:\WORK\2022\2208A\MODEL\ETABS\SC1-1\220804\2208A-SC1-1-220804-001.EDB at 2022/8/4 下午 05:49:25
ETABS Nonlinear 9.5.0 File saved as E:\WORK\2022\2208A\MODEL\ETABS\SC1-1\220804\2208A-SC1-1-220804-001.EDB at 2022/8/4 下午 05:50:36
ETABS Nonlinear 9.5.0 File saved as E:\WORK\2022\2208A\MODEL\ETABS\SC1-1\220804\2208A-SC1-1-220804-001.EDB at 2022/8/4 下午 05:51:35
ETABS Nonlinear 9.5.0 File saved as E:\WORK\2022\2208A\MODEL\ETABS\SC1-1\220804\2208A-SC1-1-220804-001.EDB at 2022/8/4 下午 05:51:47
ETABS Nonlinear 9.5.0 File saved as E:\WORK\2022\2208A\MODEL\ETABS\SC1-1\220804\2208A-SC1-1-220804-001.EDB at 2022/8/4 下午 05:56:02
ETABS Nonlinear 9.5.0 File saved as E:\WORK\2022\2208A\MODEL\ETABS\SC1-1\220804\2208A-SC1-1-220804-001.EDB at 2022/8/4 下午 09:25:15
ETABS Nonlinear 9.5.0 File saved as E:\WORK\2022\2208A\MODEL\ETABS\SC1-1\220804\2208A-SC1-1-220804-001.EDB at 2022/8/4 下午 09:25:38
ETABS Display 9.5.0 File imported from E:\WORK\2022\2208A\MODEL\ETABS\SC1-1\220804\2208A-SC1-1-220804-001.SET at 2022/8/4 下午 09:25:46
ETABS Nonlinear 9.5.0 File saved as E:\WORK\2022\2208A\MODEL\ETABS\SC1-1\220804\2208A-SC1-1-220804-001.EDB at 2022/8/4 下午 09:25:53
ETABS Nonlinear 9.5.0 File saved as E:\WORK\2022\2208A\MODEL\ETABS\SC1-1\220804\2208A-SC1-1-220804-001.EDB at 2022/8/4 下午 09:28:29
ETABS Nonlinear 9.5.0 File saved as E:\WORK\2022\2208A\MODEL\ETABS\SC1-1\220804\2208A-SC1-1-220804-001.EDB at 2022/8/4 下午 09:28:41
ETABS Nonlinear 9.5.0 File saved as E:\WORK\2022\2208A\MODEL\ETABS\SC1-1\220804\2208A-SC1-1-220804-001.EDB at 2022/8/4 下午 09:29:08
ETABS Nonlinear 9.5.0 File saved as E:\WORK\2022\2208A\MODEL\ETABS\SC1-1\220804\2208A-SC1-1-220804-001.EDB at 2022/8/4 下午 09:31:27
ETABS Nonlinear 9.5.0 File saved as E:\WORK\2022\2208A\MODEL\ETABS\SC1-1\220804\2208A-SC1-1-220804-001.EDB at 2022/8/4 下午 09:31:36
ETABS Nonlinear 9.5.0 File saved as E:\WORK\2022\2208A\MODEL\ETABS\SC1-1\220804\2208A-SC1-1-220804-001.EDB at 2022/8/13 上午 10:42:39
ETABS Nonlinear 9.5.0 File saved as E:\WORK\2022\2208A\MODEL\ETABS\SC1-1\220804\2208A-SC1-1-220804-001.EDB at 2022/8/13 上午 11:12:09
ETABS Nonlinear 9.5.0 File saved as E:\WORK\2022\2208A\MODEL\ETABS\SC1-1\220804\2208A-SC1-1-220804-001.EDB at 2022/8/13 上午 11:26:40
ETABS Nonlinear 9.5.0 File saved as E:\WORK\2022\2208A\MODEL\ETABS\SC1-1\220804\2208A-SC1-1-220804-001.EDB at 2022/8/13 下午 09:20:21
ETABS Display 9.5.0 File imported from E:\WORK\2022\2208A\MODEL\ETABS\SC1-1\220813\2208A-SC1-1-1-220813-001.SET at 2022/8/13 下午 09:20:24
ETABS Nonlinear 9.5.0 File saved as E:\WORK\2022\2208A\MODEL\ETABS\SC1-1\220813\2208A-SC1-1-1-220813-001.EDB at 2022/8/13 下午 09:26:43
ETABS Nonlinear 9.5.0 File saved as E:\WORK\2022\2208A\MODEL\ETABS\SC1-1\220813\2208A-SC1-1-1-220813-001.EDB at 2022/8/13 下午 09:29:08
ETABS Nonlinear 9.5.0 File saved as E:\WORK\2022\2208A\MODEL\ETABS\SC1-1\220813\2208A-SC1-1-1-220813-001.EDB at 2022/8/13 下午 09:29:51
ETABS Nonlinear 9.5.0 File saved as E:\WORK\2022\2208A\MODEL\ETABS\SC1-1\220813\2208A-SC1-1-1-220813-001.EDB at 2022/8/13 下午 09:29:57
ETABS Nonlinear 9.5.0 File saved as E:\WORK\2022\2208A\MODEL\ETABS\SC1-1\220813\2208A-SC1-1-1-220813-001.EDB at 2022/8/13 下午 09:31:13
ETABS Nonlinear 9.5.0 File saved as E:\WORK\2022\2208A\MODEL\ETABS\SC1-1\220813\2208A-SC1-1-1-220813-001.EDB at 2022/8/13 下午 09:33:26
ETABS Nonlinear 9.5.0 File saved as E:\WORK\2022\2208A\MODEL\ETABS\SC1-1\220813\2208A-SC1-1-1-220813-001.EDB at 2022/8/15 下午 04:33:11
ETABS Nonlinear 9.5.0 File saved as E:\WORK\2022\2208A\MODEL\ETABS\SC1-1\220813\2208A-SC1-1-1-220813-001.EDB at 2022/8/15 下午 04:33:21
ETABS Nonlinear 9.5.0 File saved as E:\WORK\2022\2208A\MODEL\ETABS\SC1-1\220813\2208A-SC1-1-1-220813-001.EDB at 2022/8/15 下午 04:55:35
END COMMENTS

END

5 END OF MODEL FILE

STEEL CODE PREFERENCES

Steel Design Code : AISC-LRFDP93
Time History Type : Step-by-Step
Frame Type : Moment Frame
Phi(Bending) : 0.9
Phi(Compression) : 0.85
Phi(Tension) : 0.9
Phi(Shear) : 0.9
Phi(Compression, Angle) : 0.9
Consider Deflection? : No
Deflection Check Type : Ratio
DL Limit, L/ : 120
Super DL+LL Limit, L/ : 120
Live Load Limit, L/ : 360
Total Load Limit, L/ : 240
Total+Comber Limit, L/ : 240
DL Limit, abs : 2.54
Super DL+LL Limit, abs : 2.54
Live Load Limit, abs : 2.54
Total Load Limit, abs : 2.54
Total+Comber Limit, abs : 2.54
Pattern Live Load Factor : 0.75
Stress Ratio Limit : 1.05
Maximum Auto Iteration : 1

COLUMN STEEL STRESS CHECK ELEMENT INFORMATION (AISC-LRFDP93)

Table with 4 columns: LEVEL, LINE ID, TYPE FACTOR, MAJOR MINOR MAJOR MINOR. Rows list column elements (C1-C8) and their steel stress ratios for various loading conditions.

BEAM STEEL STRESS CHECK ELEMENT INFORMATION (AISC-LRFDP93)

Table with 4 columns: LEVEL, BAY ID, TYPE FACTOR, MAJOR MINOR MAJOR MINOR. Rows list beam elements (B1-B19) and their steel stress ratios for various loading conditions.

BRACE STEEL STRESS CHECK ELEMENT INFORMATION (AISC-LRFDP93)

Table with 4 columns: LEVEL, BAY ID, TYPE FACTOR, MAJOR MINOR MAJOR MINOR. Rows list brace elements (D1-D16) and their steel stress ratios for various loading conditions.

COLUMN STEEL STRESS CHECK OUTPUT (AISC-LRFDP93)

Table with 4 columns: LEVEL, LINE ID, COMBO, RATIO = AXL + B33 + B22 COMBO RATIO COMBO RATIO. Rows list column elements and their steel stress ratios.

BEAM STEEL STRESS CHECK OUTPUT (AISC-LRFDP93)

Table with 4 columns: STORY, BEAM SECTION, MOMENT INTERACTION CHECK, SHEAR22, SHEAR33. Rows list beam elements (B1-B19) and their steel stress ratios.

BRACE STEEL STRESS CHECK OUTPUT (AISC-LRFDP93)

Table with 4 columns: STORY, BRACE SECTION, MOMENT INTERACTION CHECK, SHEAR22, SHEAR33. Rows list brace elements (D1-D16) and their steel stress ratios.

```
COMBOFACTOR 'BASE35' 'SDL' 0.9
COMBOFACTOR 'BASE35' 'EXN' 1.4
COMBO 'BASE36' TYPE DESIGN
COMBOFACTOR 'BASE36' 'DL' 0.9
COMBOFACTOR 'BASE36' 'SDL' 0.9
COMBOFACTOR 'BASE36' 'EYN' 1.4
COMBO 'BASE37' TYPE DESIGN
COMBOFACTOR 'BASE37' 'DL' 0.9
COMBOFACTOR 'BASE37' 'SDL' 0.9
COMBOFACTOR 'BASE37' 'EXP' -1.4
COMBO 'BASE38' TYPE DESIGN
COMBOFACTOR 'BASE38' 'DL' 0.9
COMBOFACTOR 'BASE38' 'SDL' 0.9
COMBOFACTOR 'BASE38' 'EYP' -1.4
COMBO 'BASE39' TYPE DESIGN
COMBOFACTOR 'BASE39' 'DL' 0.9
COMBOFACTOR 'BASE39' 'SDL' 0.9
COMBOFACTOR 'BASE39' 'EXN' -1.4
COMBO 'BASE40' TYPE DESIGN
COMBOFACTOR 'BASE40' 'DL' 0.9
COMBOFACTOR 'BASE40' 'SDL' 0.9
COMBOFACTOR 'BASE40' 'EYN' -1.4
$STRIP DEFINITIONS
XSTRIP '2' 0 0 290 0 290 290 0 290
YSTRIP '3' 0 0 290 0 290 290 0 290
$GROUPS
END
$END OF MODEL FILE
```

Lo-Lat Structure Studio

X - S T R I P R E I N F O R C I N G (for whole strip in Sq-cm)

X-STRIP ID	STRIP WIDTH	STATION X-ORDINATE	TOP-REBAR LEFT OF X	TOP-REBAR RIGHT OF X	BOT-REBAR LEFT OF X	BOT-REBAR RIGHT OF X
2	290.000	0.000	10.486	10.486		
2	290.000	72.500	20.972	20.972		
2	290.000	145.000	20.972	20.972		
2	290.000	217.500	20.972	20.972		
2	290.000	290.000	10.486	10.486		

Lo-Lat Structure Studio

Y - S T R I P R E I N F O R C I N G (for whole strip in Sq-cm)

Y-STRIP ID	STRIP WIDTH	STATION Y-ORDINATE	TOP-REBAR LEFT OF Y	TOP-REBAR RIGHT OF Y	BOT-REBAR LEFT OF Y	BOT-REBAR RIGHT OF Y
3	290.000	0.000	10.486	10.486		
3	290.000	72.500	20.972	20.972		
3	290.000	145.000	20.972	20.972		
3	290.000	217.500	20.972	20.972		
3	290.000	290.000	10.486	10.486		

Lo-Lat Structure Studio

B E A M R E I N F O R C I N G (flexural in Sq-cm and shear in Sq-cm/meter)

LINE ID	STATION(S) X-ORDINATE	STATION(S) Y-ORDINATE	TOP-REBAR LEFT OF S	TOP-REBAR RIGHT OF S	BOT-REBAR LEFT OF S	BOT-REBAR RIGHT OF S	SHEAR-REBAR LEFT OF S	SHEAR-REBAR RIGHT OF S
B1	0.000	0.000		0.000	0.000	0.000		
B1	72.500	0.000	0.142	0.174	0.000	0.000	0.000	0.000
B1	145.000	0.000	0.214	0.213	0.000	0.000	0.000	0.000
B1	217.500	0.000	0.174	0.145	0.000	0.000	0.000	0.000
B1	290.000	0.000		0.000	0.000	0.000		
B9	0.000	0.000		0.000	0.000	0.000		
B9	0.000	72.500	0.135	0.168	0.000	0.000	0.000	0.000
B9	0.000	145.000	0.196	0.196	0.000	0.000	0.000	0.000
B9	0.000	217.500	0.168	0.138	0.000	0.000	0.000	0.000
B9	0.000	290.000		0.000	0.000	0.000		
B12	290.000	0.000		0.000	0.000	0.000		
B12	290.000	72.500	0.138	0.169	0.000	0.000	0.000	0.000
B12	290.000	145.000	0.199	0.198	0.000	0.000	0.000	0.000
B12	290.000	217.500	0.170	0.140	0.000	0.000	0.000	0.000
B12	290.000	290.000		0.000	0.000	0.000		
B18	0.000	290.000		0.000	0.000	0.000		
B18	72.500	290.000	0.144	0.175	0.000	0.000	0.000	0.000
B18	145.000	290.000	0.216	0.215	0.000	0.000	0.000	0.000
B18	217.500	290.000	0.177	0.146	0.000	0.000	0.000	0.000
B18	290.000	290.000		0.000	0.000	0.000		

Lo-Lat Structure Studio

X - S T R I P D E S I G N M O M E N T S

X-STRIP ID	STRIP WIDTH	STATION X-ORDINATE	TOP-MOMENT LEFT OF X	TOP-MOMENT RIGHT OF X	BOT-MOMENT LEFT OF X	BOT-MOMENT RIGHT OF X
2	290.000	0.000	-1271.347	13004.938		
			BASE32	BASE27		
2	290.000	72.500	-110666.851	-104916.988		
			BASE21	BASE21		
2	290.000	145.000	-141417.547	-141213.149		
			BASE21	BASE21		
2	290.000	217.500	-105827.582	-111376.838		
			BASE21	BASE21		
2	290.000	290.000	-1210.889	13947.860		
			BASE30	BASE31		

Lo-Lat Structure Studio

Y - S T R I P D E S I G N M O M E N T S

Y-STRIP ID	STRIP WIDTH	STATION Y-ORDINATE	TOP-MOMENT LEFT OF Y	TOP-MOMENT RIGHT OF Y	BOT-MOMENT LEFT OF Y	BOT-MOMENT RIGHT OF Y
3	290.000	0.000	-1183.301	12866.661		
			BASE31	BASE28		
3	290.000	72.500	-107533.941	-101789.813		
			BASE21	BASE21		
3	290.000	145.000	-135896.751	-115689.057		
			BASE21	BASE21		
3	290.000	217.500	-102637.003	-108181.041		
			BASE21	BASE21		
3	290.000	290.000	-1111.888	13807.436		
			BASE29	BASE32		

Lo-Lat Structure Studio

B E A M D E S I G N M O M E N T S & S H E A R S

LINE ID	STATION(S) X-ORDINATE	STATION(S) Y-ORDINATE	TOP-MOMENT LEFT OF S	TOP-MOMENT RIGHT OF S	BOT-MOMENT LEFT OF S	BOT-MOMENT RIGHT OF S	SHEAR LEFT OF S	SHEAR RIGHT OF S
B1	0.000	0.000		0.000	0.000	149.71		
B1	72.500	0.000	-12850.587	-15774.043	0.000	0.000	149.71	72.14
B1	145.000	0.000	-19397.180	-19323.140	0.000	0.000	72.14	59.48
B1	217.500	0.000	-12808.958	-13150.018	0.000	0.000	59.48	159.27
B1	290.000	0.000		0.000	0.000	159.27		
B9	0.000	0.000		0.000	0.000	142.74		
B9	0.000	72.500	-12278.150	-15197.702	0.000	0.000	142.74	57.72
B9	0.000	145.000	-17788.717	-17781.775	0.000	0.000	57.72	45.66
B9	0.000	217.500	-15222.053	-12513.524	0.000	0.000	45.66	151.09
B9	0.000	290.000		0.000	0.000	151.09		
B12	290.000	0.000		0.000	0.000	152.76		
B12	290.000	72.500	-12514.049	-15339.108	0.000	0.000	152.76	59.31
B12	290.000	145.000	-18000.150	-17948.367	0.000	0.000	59.31	40.15
B12	290.000	217.500	-15432.227	-12657.320	0.000	0.000	40.15	149.30
B12	290.000	290.000		0.000	0.000	149.30		
B18	0.000	290.000		0.000	0.000	158.80		
B18	72.500	290.000	-13081.878	-15909.195	0.000	0.000	158.80	73.70
B18	145.000	290.000	-19556.245	-19504.346	0.000	0.000	73.70	54.02
B18	217.500	290.000	-16013.585	-13236.795	0.000	0.000	54.02	156.27
B18	290.000	290.000		0.000	0.000	156.27		